

DIFFUSER

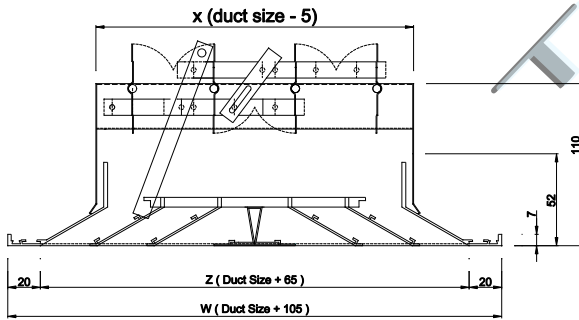

DIFFUSER

Diffuser berfungsi untuk mengeluarkan udara dari saluran udara

Material : BJLS, Alumunium
Finish : Baking Paint, Powder Coating , Anodize.

	X	W	Z
# 150	145	255	215
# 200	195	305	265
# 250	245	355	315
# 300	295	405	365
# 350	345	455	415

LINIER DIFFUSER

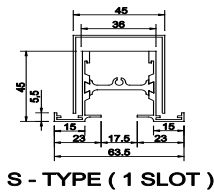

LINIER DIFFUSER

Diffuser berfungsi untuk mengeluarkan udara dari saluran udara

Material : BJLS, Alumunium
Finish : Baking Paint, Powder Coating , Anodize.

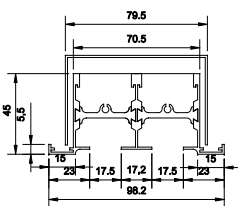

D - TYPE (2 SLOT)

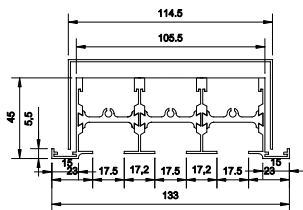

T - TYPE (3 SLOT)

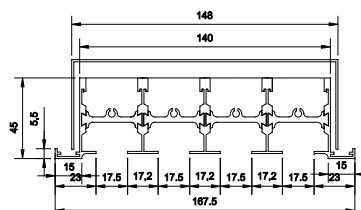

Q - TYPE (4 SLOT)

NOZZLE



Nozzle

Nozzle berfungsi untuk mengeluarkan udara dari saluran udara.

Nozzle dapat diaplikasikan dengan menambahkan shutter dan non shutter

Material : Galvanized, SUS

Finish : Baking Paint, Powder Coating.

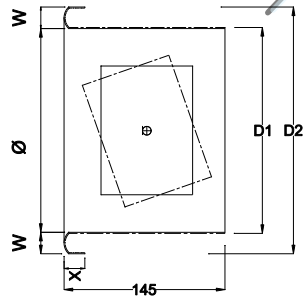
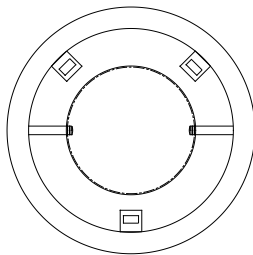

NO	SIZE(Φ)	D1	D2	X	W
1	250	245	285	15	20
2	200	195	235	15	20
3	150	145	185	15	20
4	100	95	125	10	15

